

ESPECIFICACIONES TÉCNICAS / ACABADOS
TECHNICAL DATA / FINISHED

DAU SPOT / 6026

Flemming Bjorn

AL

Ø 528

H 260

3 x GU10 | 75 W. | $\triangle 50^\circ$ |  Dim.

3 x GU10 | 5 W. | 210 lumens | 2800 K | $\triangle 30^\circ$ | 

 | 

DESCRIPCIÓN
DESCRIPTION

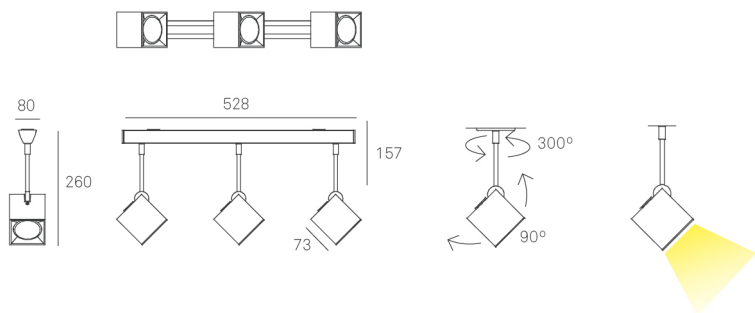
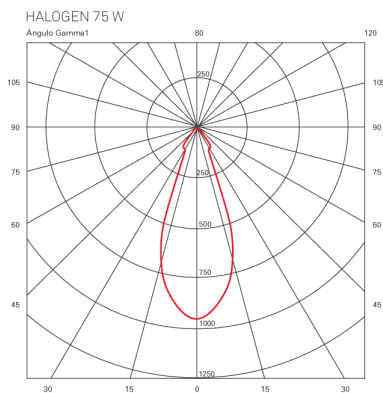
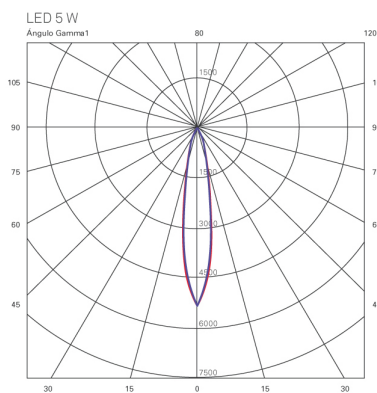

COMENTARIOS / COMMENTS